



H.265 IP Video Doorbell



POE



2.4GHz WiFi



Full duplex



Record



Camera



Unlock



Full HD



Night Vision



Motion Detect



Multi-user



Call



Playback

1 Function

Network	2.4G WiFi 802.11 b/g/n or Wired network
Power adapter	DC 12~36V AC 8~24V or 12~15V or 48V POE
Function	Full duplex talk, Take photo, Take video, Unlock
Unlock	Unlock by remote control, ID Card or APP
External memory	MicroSD card up to 256GB
Resolution	2Mega pixels
View angle	140 Horizontal angle
Night vision	IR CUT no color deviation, B/W night vision
Alarm message	Push picture to APP when motion detection or call
Playback	Video recording after the call or motion detection
Third-Party Services	Amazon echo, Google Home, Cloud storage

2 Specification

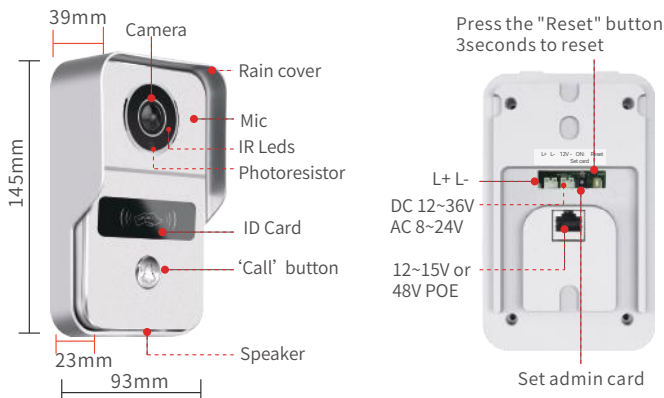

3 Parts List

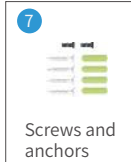

4 System diagram

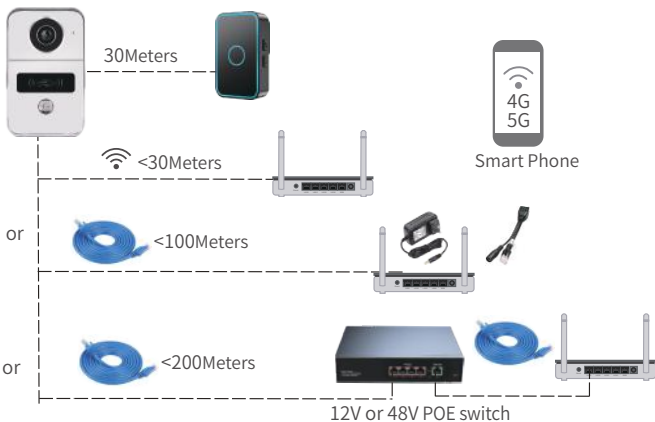

5 Installation diagram

The doorbell is installed at a height of 1.4~1.7 meters, try to avoid the sunshine and rain, Using 2 screws or tape fixed the doorbell on the wall, wooden board, door, It can also be installed on the 86 box.

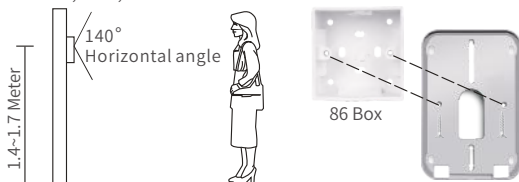

Use the drill bit to drill three holes. One hole is large enough to pass through the LAN cable, use anchors if you install video doorbell on brick or concrete.

1. Remove the screws of the rain cover
2. The rain cover is separated from the doorbell
3. Insert the TF card
4. Fix the rain cover with two screws

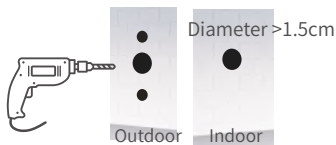

Option 1: Connect doorbell to WiFi and 12V power supply.

Make sure that have a strong WiFi connection at the location of video doorbell.

5. Plug the DC cable into the power socket
6. Pass the DC cable through the hole on the wall
7. Plug the rain cover on the host and fix the bottom screws.
8. Connect the 12V power supply to the female end of the DC cable

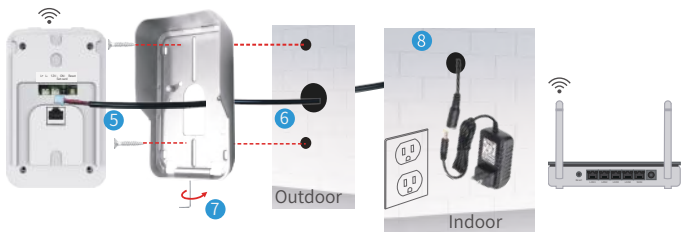

Option 2 (recommended):

The network cable is connected to a 12V router or 12~15V or 48V POE switch.

5. Connect the network cable to the network port of the doorbell
6. Plug the rain cover on the doorbell and fix the bottom screws
7. Connect the doorbell via LAN Cable at RJ45 port to POE injector and into Router.

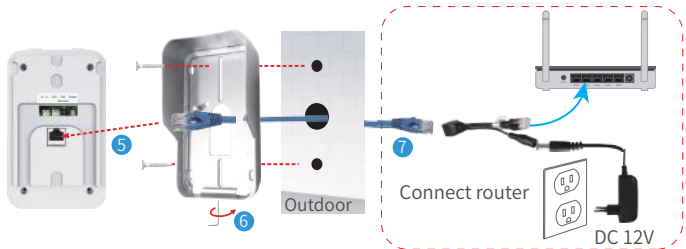

8. Or connect the doorbell via LAN Cable at RJ45 port to POE switch.

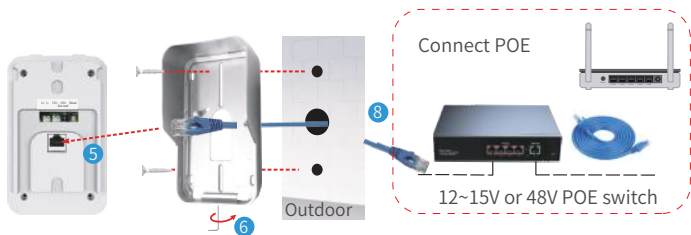

6 Schematic diagram of connect the lock

1. There is no power at the door connected to the electric lock

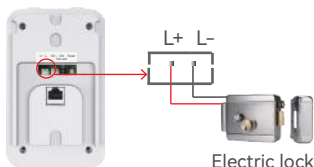

2. Connect to the 12V 3A power supply

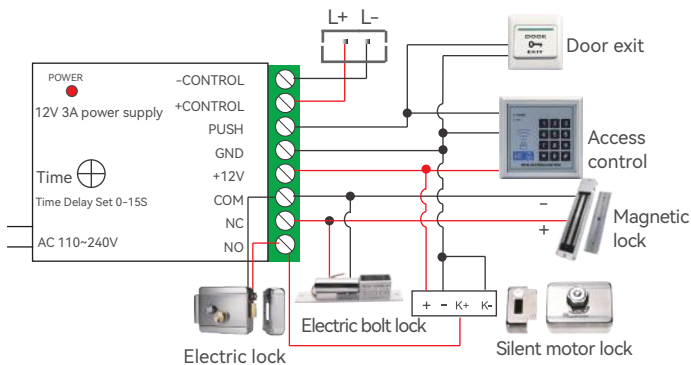

7 Device pairing

1 Pair indoor chime with smart doorbell

1. Long press the "volume" button of indoor chime until the light stays on, then long press the "call" button of IP video doorbell to pair.

2. Clear the pairing

Press and hold the "Volume" button of indoor chime without connecting the power supply, then connect the power supply until the light stays on.

2 Pair unlock control with smart doorbell

1. Press the "pair" button of the unlock control, the pair light will flash once, then press the "Unlock" icon on the app, the pairing light will continue to flash.
2. Then press the "pair" button of the unlock control again, the light will stop flashing, then press the "Unlock" icon on the app again, the pairing light will flash several times. The pairing is successful.
3. Clear the pairing
Press the "pair" button on the unlock control for longer than 3 seconds until the light on to off.

3 Pair remote control with unlock control

1. Press the "pair" button of the unlock control, the pair light will flash one time, then press the "unlock" button of the remote control, the pair light will flash continuously.
2. Then press the "pair" button of the unlock control again, the pair light stops flashing, then press the "unlock" button of the remote control again, the pair light will flash several times. The pairing is successful.

8 RFID Card Settings

The factory default includes 1 admin add card(yellow), 1 admin delete card(red), 5 user cards(blue), ID card working frequency is 125KHZ.

1. Set the admin card

1. Set to 'on' of ID card setting button, both red and yellow lights are on
2. Then swipe a ID card, the card will be the admin add card, the blue light is off
3. Then swipe the second card, the card will be the delete card, the red light off
4. Set to '1' of ID card setting button, then exit the setting mode.



2. Add user card

1. Swipe the admin add card
2. Then swipe a ID card, the card will be the user card
3. Continue to swipe the ID card to add the user card.
4. Swipe the admin add card

3. Delete User Card

1. Swipe the admin delete card
2. Then swipe a ID card, then delete the user card
3. Continue to swipe the card to delete the user card
4. Swipe the admin delete card

4. Delete all user cards

1. First swipe the admin delete card
2. Then swipe the admin add card
3. Then swipe the admin delete card again, so delete all user cards!

9 App Download

1. Search "Tuya Smart" or "Smart life" from APP store or Google Play.
2. Scan the QR code to download.



10 Register & Login

1. Please register when using APP for the first time.
2. After logging on the APP, please add devices after creating a family. At the bottom right corner of the APP homepage, click "Me" -> "Home Management" -> "Create a home", fill in the information and save it. the setter will become the family owner, you can set home owner or common members.
3. After the home owner adds the device, the home members will add the device automatically. After adding this doorbell, all home members have unlock function than shared accounts. You can add 20 administrators or home members.
4. The video doorbell is a device with a higher security level, the device must be removed from the original account before it can be bound to another account.

11 Add device to APP

- 1 Click "+" -> "Add device" on the top right of the APP.

11.1 QR code and EZ Mode connection if doorbell connect to WiFi

- 2 Select "Camera & Lock" -> "Smart Doorbell".

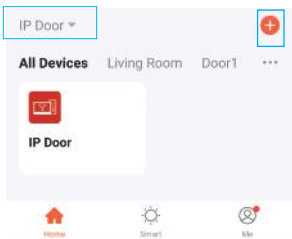

1

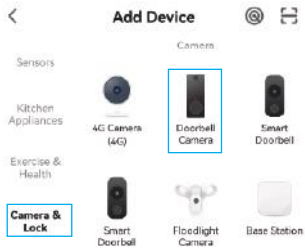

2

- 3 Select "QR Code".

- 4 The blue light of the doorbell flashes quickly, after checking, click "Next".



3

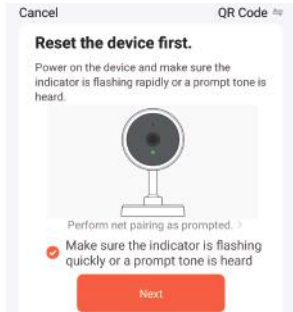

4

The doorbell only supports 2.4G WiFi, not 5G WiFi signal!

- 5 Select 2.4GHz WiFi, enter the WiFi password, and click "Next".
- 6 A QR code appears in the APP. Please scan the QR code from 15 to 20cm away. After you hear the doorbell prompt, click "I Heard a Prompt".

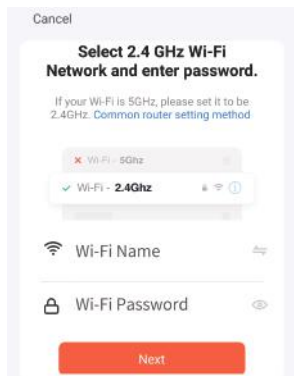

5

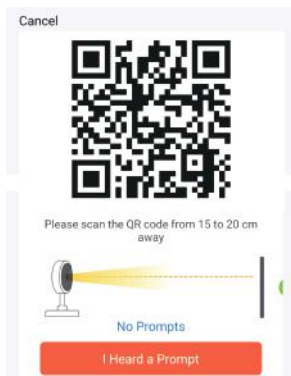

6

- 7 Enter the "Adding device..." then "Scan devices." -> "Register on Cloud" -> "Initialize the device".
- 8 After the completion, it shows that the added successfully, you can modify the device name, and click "Done" to finish the adding the device.

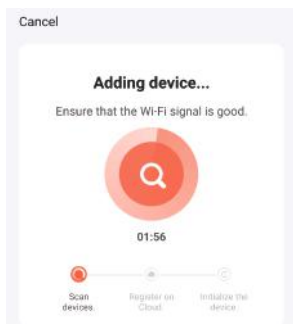

7

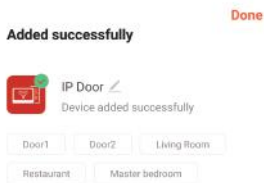

8

11.2 Wired network connection

1 "Manually add" -> "Cable"

- 1 Click "+" on the top right of the APP homepage.
- 2 Select "Add Manually" -> "Security & Video Surveillance" -> "Smart Doorbell".
- 3 Select "Cable". After checking, Click "Next" if the blue light of the doorbell flashes quickly.
- 4 Waiting for connecting.
- 5 Select Device to Add.

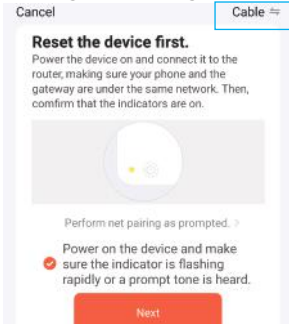

- 6 Wait for "Device found" -> "Register to Cloud" -> "Initializing device".
- 7 After the completion, it shows that the addition is successful, you can modify the device name, and click "Finish" to enter the video interface.

2 "Auto Scan"

- 2 Select "Auto Scan".
- 3 Select device to be added and click "Next".
- 4 Wait for the connection.
- 5 Add successfully after click "Done".

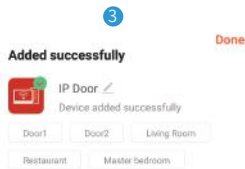
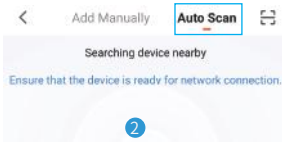

12 View live video

Click on the device to enter the liveing screen,

You can take photos, talk, video, unlock, playback(TF Card), and view albums.

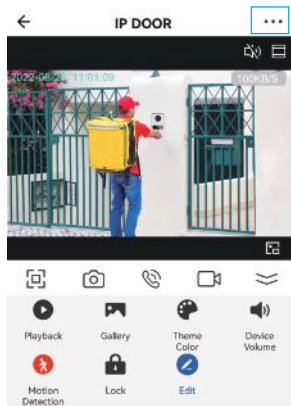

Click the button in the upper right corner to enter the setting interface.

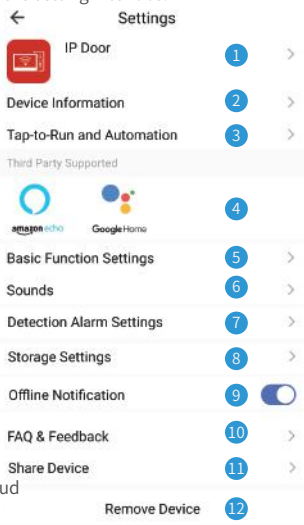

Unlock: Unlock and save all records.

Message: Take photos and videos during incoming calls or motion detection.

Cloud: The photos and videos stored in the cloud server during incoming calls or motion detection, do not worry about losing the doorbell.

- 1 Modify icon, name, location of device.
- 2 View IP address, ID, time zone.
- 3 Configure the device automation.
- 4 Connect Amazon echo or Google Home.
- 5 1 Turn on/off the light of the doorbell button 2 The screen horizontal mirroring.
- 6 Adjust the volume of the doorbell
- 7 Motion detection on/off, set the alarm sensitivity and the alarm time period.
- 8 Check the capacity of the memory card, and format the memory card.
- 9 The device will push the alarm information list to the APP after 30 minutes
- 10 Please check the common problems carefully.
- 11 Enter the mobile phone number or email address of the user you want to share, click "Finish", the shared user cannot unlock.
- 12 After removing the device, the device will not be displayed on the device list. Connect this doorbell to the computer in Europe <https://protect-eu.ismartlife.me>, Connect this doorbell on the computer side of the United States <https://protect-us.ismartlife.me>, The PC can talk, take pictures, and video.

13 Ring the bell and Motion Detected

1. After the visitor presses the call button, push notifications online

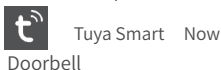

2. The mobile phone standby state is pushed notifications as follows



Motion detected

IP Door has detected movement

You have a visitor

IP Door, someone is ringing the bell



Click the "Settings" icon in the upper right corner to enter the notifications push settings

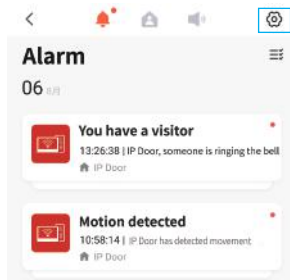

- 2.1 Click the "Motion detected" to enter the alarm message

- 2.2 Click the "You have a visitor" to enter the living video.



Alarm

05 August

- 1 You have a visitor
14:10:20 | IP Door, someone is ringing the bell
[View](#)



- 1 Motion detected
14:08:30 | IP Door has detected movement [View](#)



Notifications Setting

- Enable Notifications
- Alarm
- Do-Not-Disturb Schedule [Not set >](#)
- Home
- Bulletin

14 Multi-Video Preview

If the APP is connected to more than 1 video device. Multiple devices can be viewed at the same time.

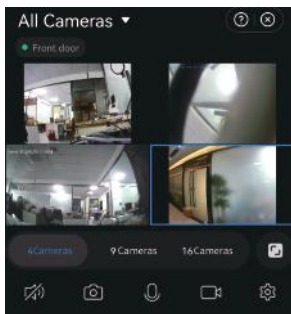
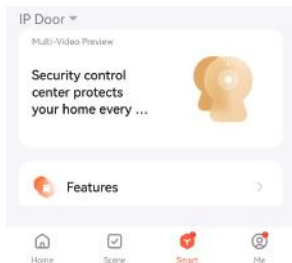

15 Help and service

Users can click "Me" of homepage on the APP to enter "service and help".

1. "Voice third-party service", you can choose multiple smart product voice control products, each third party, the third-party service have detailed connection tutorials.
2. "Home Management" can create a home or join a home and set permissions
3. "Message Center" can view alarm information
4. If you are not familiar with the app or device, pls check "Help and Feedback".

